

eurotech[®]

FIRE SYSTEMS LIMITED

thefirebeam[™] protectionsystemBLUE

USER GUIDE

Issue 0165-04
01.08.23 Rev. 04

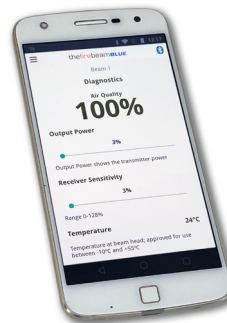
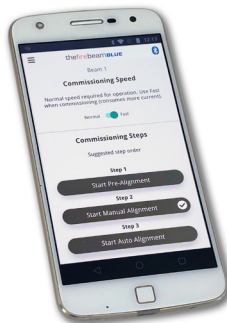
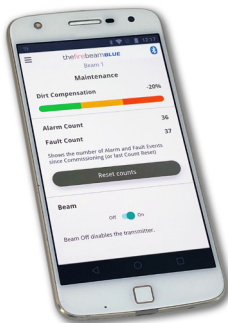
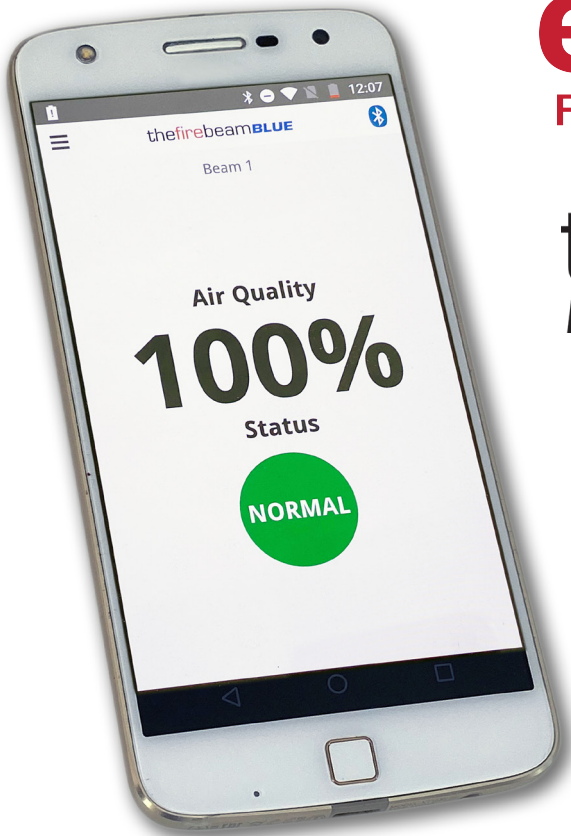

thefirebeam™ protection system **BLUE**

Congratulations on purchasing the firebeam **BLUE**
reflective optical beam smoke detector

In this manual we will lead you through the simple steps of
positioning the beam and setting it up using our unique App



Further information can be found on
www.firebeamsupport.com

DISTANCE AND POSITION GUIDELINES

These guidelines are recommendations only and it is important that you refer to your appropriate governing standards at all times

When positioning your *firebeam* there are important factors that you should consider, mainly what distance you are covering and the optimal position in the building **Please note: The maximum Bluetooth range from the beam head to your mobile device is 20m in open space. This can be affected by the environment, your mobile device hardware and software**

WHAT DISTANCE?

The standard *firebeam* is suitable for distances of **7m to 70m** using the single reflector supplied



NOTE. For distances **under 20m** use the short range mask supplied on the single reflector



If you require **70m to 140m** you will need the standard *firebeam* and add to it the **mid range extension kit**

(The mid range kit comes with a backing plate and 3 extra reflectors, you will need to add the reflector from the standard kit to the mid range kit with the screws provided)

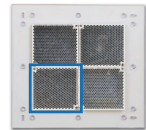

If you require **140m to 160m** you will need the standard *firebeam* and add to it the **long range extension kit**

(The long range kit comes with a backing plate and 8 extra reflectors, you will need to add the reflector from the standard kit to the long range kit with the screws provided)

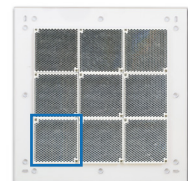

WHAT POSITION?

A roof is considered flat unless the height of the apex is greater than 0.6m. If the roof is flat the firebeam system can be placed anywhere under the roof between **0.3m and 0.6m** below the roof, up to a maximum height of **20m** from the floor.

Note: For locations above **20m** where Bluetooth connection is not achieved, you will need to bring your mobile device within Bluetooth range, this may require the use of lifting equipment or similar

the firebeam has a detection area of **7.5m** either side of the beam

Flat roof

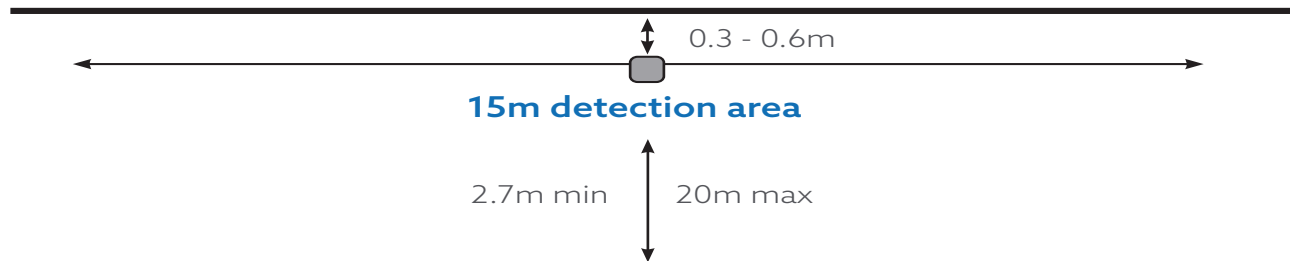

Apex roof

If the roof is considered to have an apex, place the firebeam system **0.3m to 0.6m** down from the top of the apex, up to a maximum height of **20m** from the floor

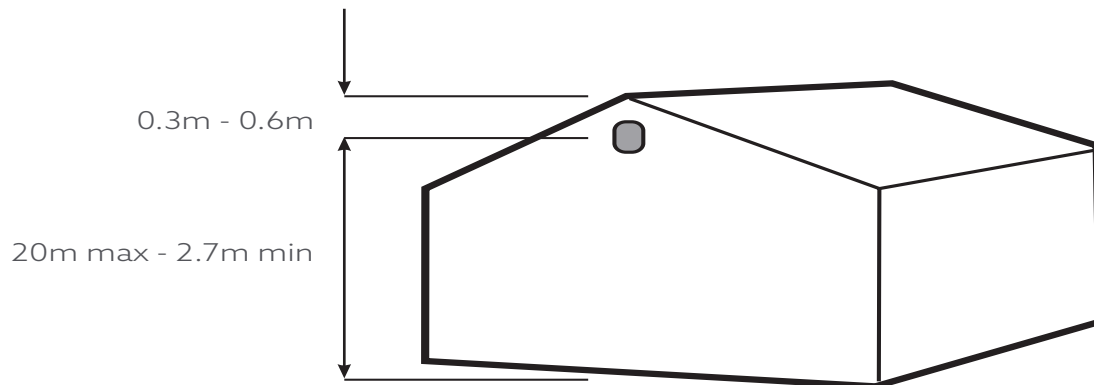

Extra coverage due the apex angle

The maximum protected area either side of the beam can be extended by 1% for every degree of roof pitch, see the example below: (please check with your local regulations)

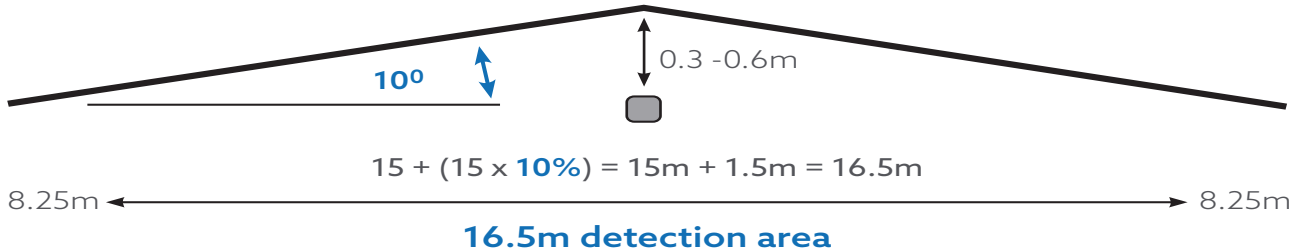

Field of view

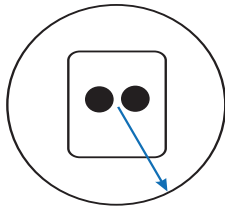

Field of view should be a 50cm radius from the centre of the beam

Warning: So that the beam works effectively, ensure the beam is not obstructed in a 1m diameter clear line of sight along its entire axis

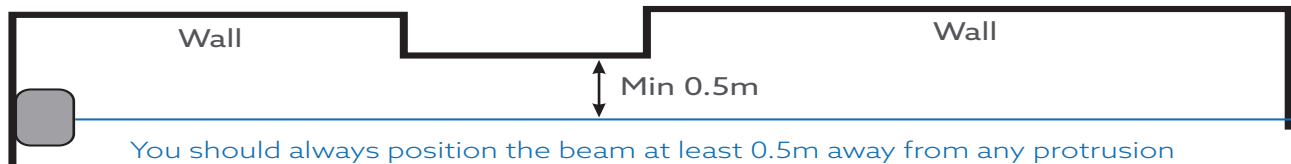

Note: Careful design consideration should be made when positioning beams and reflectors in environments that can be susceptible to condensation i.e. warehouses near to water that have areas open to the outside environment or that are exposed to quick extreme changes in temperature

To assist with this problem that can affect all beam detectors we produce an anti-fog kit comprising of a specially coated reflector and lens cover. Individual reflectors are also available. The standard *fire* beam and range kits can be supplied as anti-fog sets as a special order

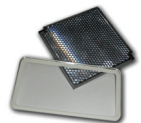

INSTALLING THE HEAD

Screw the head backing plate to the wall

Always try to use as sturdy a location as possible, such as brick or major structural steels (avoid mounting to outer metal cladding etc). Avoid mounting the head where direct sunlight can shine directly into the 'eyes' of the beam (care should be taken when mounting in glass atriums). Ambient sunlight will not affect the beam

2 knock-outs are provided on both sides.

Take care when using drills not to damage the circuit board. Only punch out with head open and disconnected from power

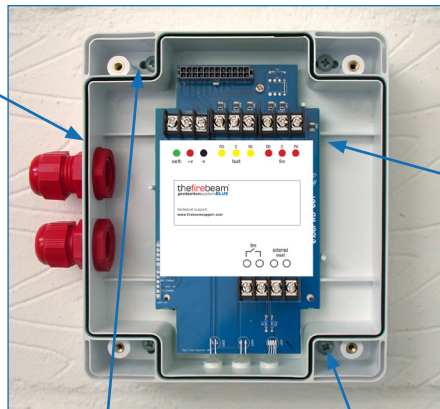

Wire into system as required (see generic wiring diagram on the following page)

Ensure that all wiring is below the level of the front edge of the box

Screw in through holes provided outside of the rubber seal

Also available - unistrut adapter plate

Use this accessory for easy mounting to unistrut fabrication. Holes are pre-drilled to the correct pitch of the head and conveniently positioned for use with unistrut

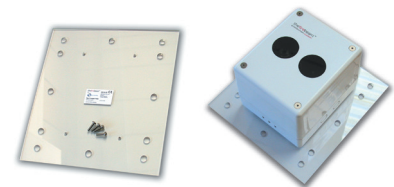

GENERIC WIRING CONFIGURATIONS

the**fire**beam is a conventional device

Here are suggested wiring configurations for single and multi heads on a zone

Most wiring diagrams can be found on our website in more detail and in PDF format, go to [www.the**fire**beam.com](http://www.thefirebeam.com)

- Brown + supply (normal 12 - 30Vdc)
- Blue - supply (return)
- Black zone +
- Grey zone -
- Green earth (screen)

Supply voltage	12Vdc to 30Vdc
Supply Current	5.5mA in Normal Speed
Supply Current	13.5mA in Fast Speed
Fault/Alarm relay contact rating	2A @ 30 Vdc

Single head on zone

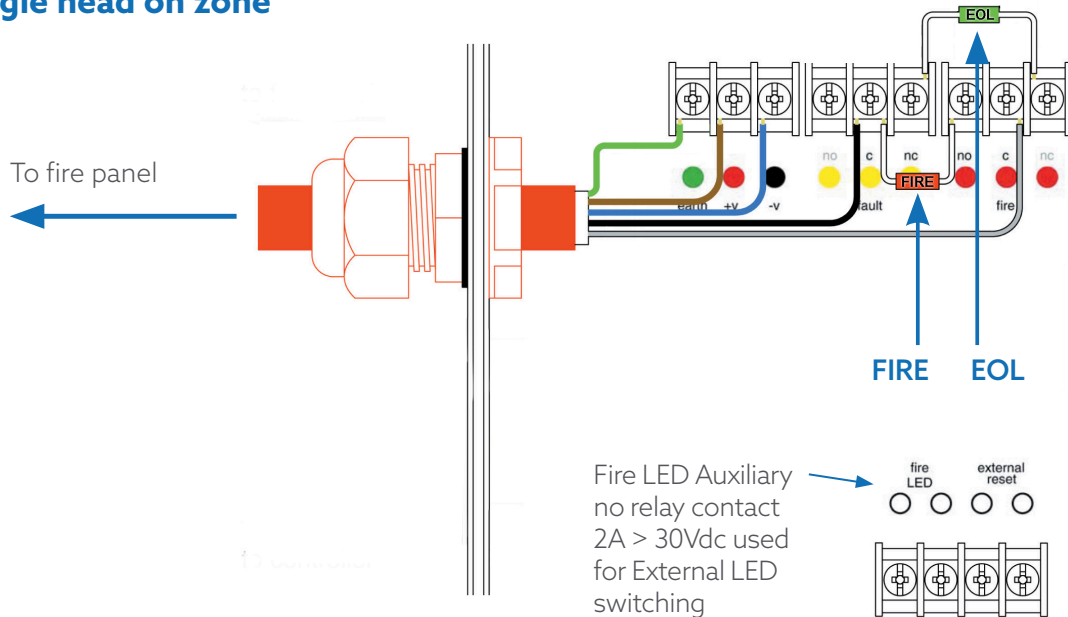

Multiple beams on a zone

Schottky barrier diode 1A 60V

MBR160TR (RS 469-0714 or MBR160RGL) (farnel 9556761)

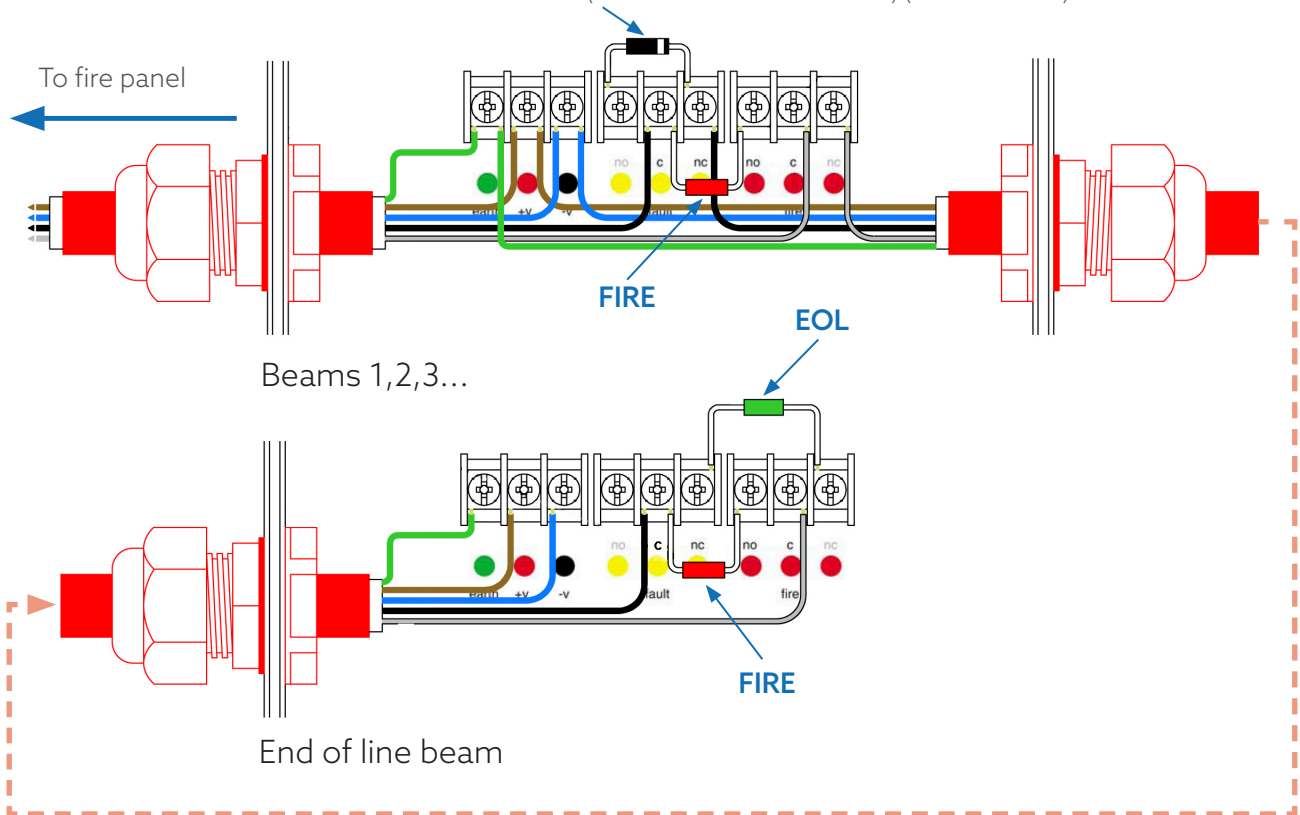

OTHER WIRING DIAGRAMS

See our support website for further diagrams. www.firebeamsupport.com

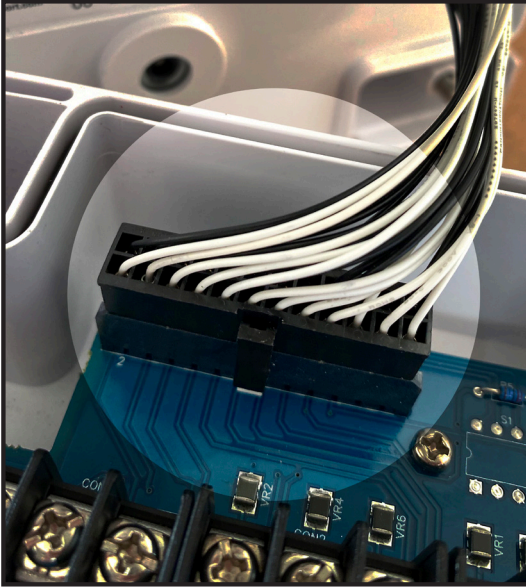

Connect the head to the base plate by first plugging in the connector. Push connector all the way so that the thumb latch is effective

If detaching detector head, squeeze the thumb latch and pull off the connector. To avoid straining the PCB, support the PCB whilst doing this

If you forget to connect the head to the circuit board, the App will show **Connecting** continuously whilst trying to connect to a powered detector head.

To avoid damaging the detector head, never dangle the front cover assembly from the ribbon cable



Screw the head screws down with the 3mm allen key provided

Your wiring should be flush and not flattened by tightening down screws

COMMISSIONING YOUR BEAM

the **firebeamBLUE** is controlled by an App using your smart phone or tablet

You must first download the firebeamBLUE App for your ANDROID or IOS device

When installing the firebeamBLUE App from the App store, you must allow Location Permission when prompted, otherwise the App cannot function

For **Android** and **iOS** devices **scan the QR code** below



Notes: To be able to **register, login** or **reset password**, your mobile device must have **WiFi turned on**

For the App to be able to communicate with the beam, your mobile device must have **Bluetooth turned on**

On smaller handsets (e.g. iPhone SE) if menus overflow the display, **reduce text size in Settings**

The new **V2** version of the **firebeamBLUE** app now includes an optional passcode facility for added security and a provision to delete your account if you no longer wish to use it
It is compatible with the previous V1 **firebeamBLUE** beam detector

REGISTERING YOUR APP

Once you have downloaded the App you will need to register it

To **REGISTER** to use the App enter

COMPANY NAME

EMAIL ADDRESS (this is not case sensitive)

PASSWORD (this is case sensitive)

REVIEW firebeam's Terms and Conditions by clicking the link

RETURN TO THE APP and move slider to the right to confirm agreement

Press **REGISTER** (selecting Already registered? will return you to the Login menu)

You will receive a firebeam**BLUE** Email Verification email from The Fire Beam Company

In the email, click **CONFIRM EMAIL ADDRESS** and wait for the Email confirmation screen to pop up. This must be done before you can Login

Select **ALREADY REGISTERED?** to go to Login menu

Login by entering your **EMAIL ADDRESS** and **PASSWORD** at Login menu and press **LOGIN**

If you have forgotten your Password select **RESET PASSWORD** and enter **EMAIL ADDRESS** and press **RESET PASSWORD** and **OK**

You will receive a Your firebeam**BLUE** Password email from thefirebeamcompany. In the email, click **RESET YOUR PASSWORD** and in the Password Reset screen **TYPE YOUR NEW PASSWORD** and **SUBMIT**

Note: check your spam/junk folder if you do not immediately receive an expected firebeam**BLUE** Email Verification or Your firebeam**BLUE** Password email

*Adding **email app@thefirebeamcompany.com** to your address book reduces the probability of Verification Emails going to your spam/junk folder*

If you no longer use the firebeam**BLUE** App and want to **REMOVE YOUR REGISTRATION**, in the Settings menu select **DELETE ACCOUNT** and enter your registration password to remove your account details. You will no longer be able to use the firebeam**BLUE** App

Commissioning the **firebeam** is a simple procedure outlined in the following step by step explanation. To avoid interrupting Commissioning, do not close the App whilst Commissioning is in progress

Ensure the installation guidelines have been followed correctly and that the **firebeam** has a clear line of sight through to the reflector and there are no obstacles in its path

IMPORTANT DO NOT put the reflector up. However, if you are recommissioning the **firebeam** **COVER** it with a non-reflective black cloth or similar. **You cannot commission the beam if the reflector can be seen**

LOG IN

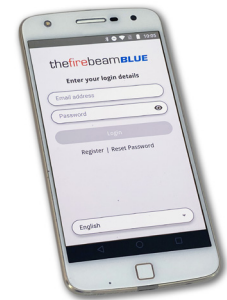
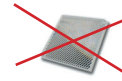

Open up the App on your device the first screen prompts you to login **Enter your email and password you set up when registering the App** You can also **change to your chosen language** on this screen

STEP ONE

Connecting to a beam

Once logged into the App the screen you will prompt you to connect to a beam. The App will scan for devices and you will see all available **powered** beams seen by your device

After Connecting to a beam, a **passcoded** beam will need a Passcode Entry (*later we explain all about the optional passcode on page 27 in Settings menu*). If the Beam has been previously passcoded, you will have 3 attempts to enter the correct passcode



Connect to your chosen beam



Enter passcode if needed

Your screen will default to fire or fault with a low AQ reading This is normal

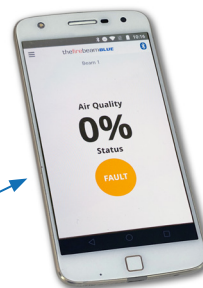

The beam you have connected to will display a **BLUE FLASHING LED**

This is especially useful if you have many beams in one location

STEP TWO

Commissioning screen

From the side screen or burger stack select commissioning



Commissioning speed

It is recommended to use **FAST** speed in commissioning (in normal speed the system uses 5.5mA, in fast speed it uses 13.5mA). Fast speed allows x4 times faster motor response and it will be quicker to commission your beam. Once commissioning is complete the firebeam will automatically revert to normal speed mode - (5.5mA)

STEP THREE

Commissioning - PRE ALIGNMENT

This is the most important part of setting up your beam.

Remember no reflector.

Pre-alignment sets up the amount of power you need for the distance you are covering and can indicate if you are receiving unwanted reflections from anything else in the beam path

Press **PRE-ALIGNMENT** and the receiver sensitivity will start by raising to 100% and then the output power will then rise to 100%. More power will be output than is necessary to cover the distance and these levels will then be reduced once the auto align process takes place. The air quality figure at this point should normally stay at 0%. **At shorter distances, output power and sensitivity will rise by lesser amounts and the air quality may fluctuate or if there are unwanted reflections in the beam path**

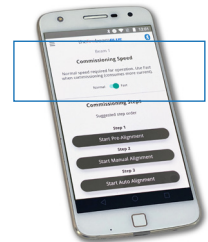
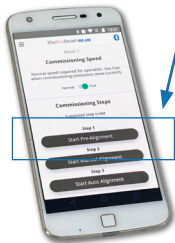

Press **ACCEPT PRE-ALIGNMENT** when you are happy with your pre-alignment readings

For tips on Pre-Alignment look at our FAQ's which can be found on www.firebeamsupport.com

PRE ALIGNMENT - continued

CAUTION: If you have not allowed the 50cm radius and the firebeam encounters an obstruction this will also stop raising the IR Power and halt the Pre Alignment as the beam will assume it has found the far wall. You will need to identify and move the obstruction or reconsider the positioning of the firebeam. You can identify that the beam is obstructed if the Air Quality rises and may fluctuate between 5%-15%

Obstructions near the head will disturb the pre-alignment process and care should be taken to ensure no solid objects are close to the beam path

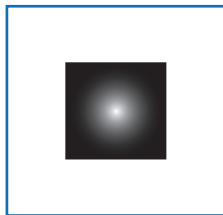
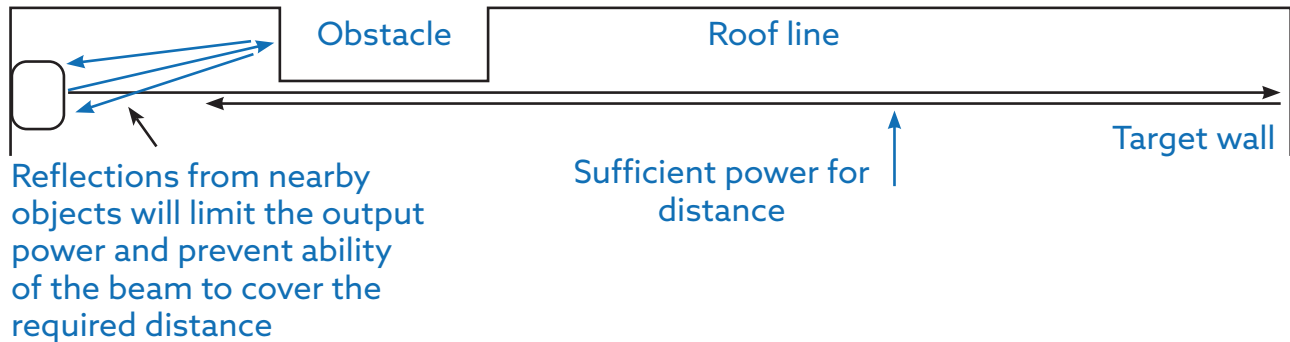

Ensure 1m of clear space along the path of the beam and 500mm from the edges of the reflector

if the wall you are placing the reflector/s on is shiny or glass then the reflectors should be placed on a 1 metre piece of non-reflective material like MDF to ensure correct operation

STEP FOUR

Commissioning - MANUAL ALIGNMENT

Having accepted Pre-Alignment you will return to the main commissioning screen. The next stage is manual alignment. You will notice a tick has appeared on the Pre-Alignment bar. This is to let you know you have completed this step

Start Manual Alignment

NOW place or uncover the reflector

When you install or uncover the reflector the Air Quality will jump up as high as 135%, this clearly shows that the firebeam can see the reflector. **As long as there is a received signal of at least 80 to 100% ideally over 100% you can accept Manual Alignment and move onto the next stage: Auto Alignment**

If the firebeam **AQ does not rise significantly** you will need to use the **Left-Right-Up-Down** keys to move the Eyes of the firebeam onto the reflector and once you have targeted the firebeam onto the reflector the AQ will rise significantly

In the example below we can see that the reflector is below the eye line of the firebeam head, so in this case you would need to lower the angle of the beam (-Y) until you receive an AQ of over 100%.

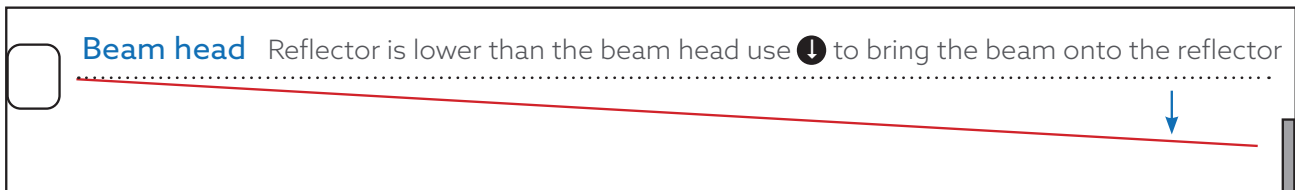
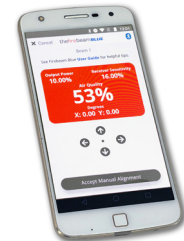
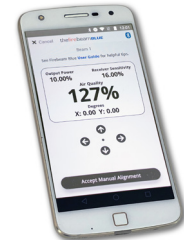

MANUAL ALIGNMENT - continued

the firebeam can be moved on both axis to a maximum 5 degrees.

Looking at the reflector this will move the beam across the reflector

To confirm the beam is seeing the reflector **covering** the reflector at any time should drop the AQ and prove the beam is on the reflector

Try and achieve as high an AQ as possible, it must be at least 80 to 100% ideally above 100%. **Once you have achieved this you can Accept Manual Alignment move onto Auto Alignment**

For tips on Manual Alignment look at our FAQ's which can be found on www.firebeamsupport.com



STEP FIVE

Commissioning - AUTO ALIGNMENT

Having accepted Manual Alignment you will return to the main commissioning screen. The next stage is Auto Alignment. You will notice a tick has appeared on the Manual Alignment bar to let you know you have completed this step

Start Auto Alignment this is an automatic process that will firstly reduce the Receiver Sensitivity and then Output Power to accommodate the best settings for the firebeam's environment

the firebeam will automatically align to the centre of the Reflector, you will notice the X and Y axis moving as the firebeam moves up, down, left and right to find the centre point

CAUTION: This process should take up to 10 Minutes, if the firebeam does not complete after this time then look at the X and Y axis to check it has not deviated off the reflector onto an obstruction. The X and Y figures should be below 1.50 on each axis and would normally be below 0.90

If this is not the case you may need to start the Manual Alignment process again to return both the firebeam axis to 0.00 then **identify and remove any obstruction and return to Auto Alignment**

When finished the firebeam will state Auto Alignment Complete  and pressing **Done** to confirm completes Auto Alignment

Returning to the Home screen will show

For tips on Auto Alignment look at our FAQ's which can be found on www.firebeamsupport.com

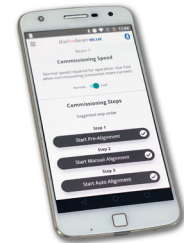

STEP SIX

Commissioning - TESTING

the firebeam should now be tested for Fire and Fault

the firebeam must be tested at the reflector end and not at the Fire Beam head. This is to confirm it is looking at the reflector and completes the commissioning process.

FAULT - Cover the reflector within 1 second with a non reflective card to simulate a fault such as a fork truck breaking the path of the firebeam. After 10 Seconds the firebeam should register **FAULT** and the Amber light will flash.

FIRE - Cover the reflector slowly up to 70% with a non reflective card to simulate a fire such as smoke entering the path of the firebeam. After 10 Seconds the firebeam should register **FIRE** and the Red light will flash.

Once you have successfully completed both tests your firebeam is commissioned.

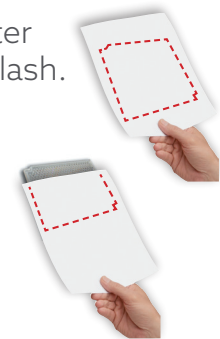

For tips on Testing look at our FAQ's which can be found on www.firebeamsupport.com

USING THE MENU

Now your beam is commissioned you will be able to use the rest of the **firebeam** features

The menu system can be accessed by **SWIPING TO THE RIGHT** or by pressing the **BURGER STACK** in the top left hand corner



The Side Draw menu contains the following items:

Home page 19

Commissioning page 20

Mode Change page 21

Maintenance page 24

Diagnostics page 25

Fire Test page 26

Connect to Firebeam page 26

Settings page 27

EXPLAINING EACH MENU ITEM

HOME

Shows Beam Name, Air Quality and Status

NORMAL, FIRE, FAULT, COMP, DIRT COMP LIMIT, ALIGN

NORMAL

Beam in normal operation



FIRE

Fire relay is triggered

Also shows if relay is latching or auto reset

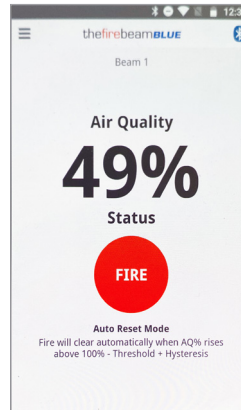

FAULT

Fault relay is triggered

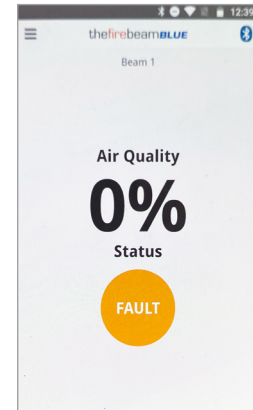

COMP

compensation has been made for dirt build up on lenses



DIRT COMP LIMIT

Compensation limit has been reached

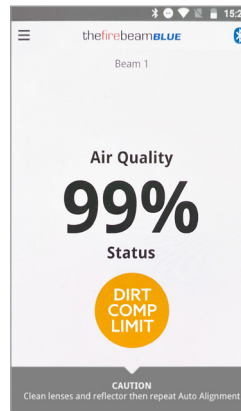

ALIGN

Beam is performing an Auto Align

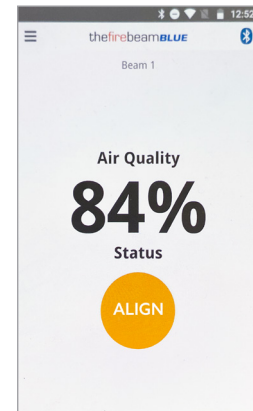

COMMISSIONING

For a full explanation of the commissioning procedure see page 12

The commissioning menu shows

Beam Name

Of the beam you are looking at

Commissioning Speed

Use slider select Normal or Fast speed. Speed will revert to Normal when leaving Commissioning menu

Start Pre-Alignment

Starts Pre alignment. **Warning - re-setting this will reset the beam to factory settings.** A tick appears when this has been performed in your commissioning procedure. The tick will disappear when you log out

Start Manual-Alignment

Allows manual alignment. This lets you to manually move the beam path up - down - right - left. **Use this to move the beam path onto the reflector.** A tick appears when this has been performed. The tick will disappear when you log out

Start Auto -Alignment

This performs an Auto-Alignment. This lets you to automatically move the beam path up - down - right - left to align the beam. A tick appears when this has been performed. The tick will disappear when you log out

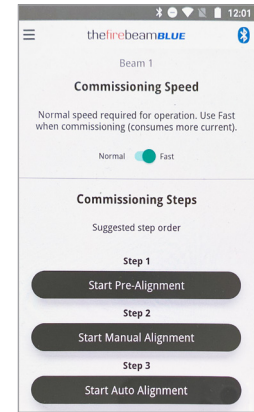

MODE CHANGE

Here we can make changes to how the beam behaves

The App text explains the function of each setting, here are additional notes

Threshold

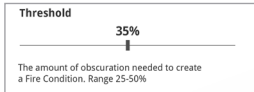

Use the **slider** to increase or decrease the beam's sensitivity. It is factory set at 35% (meaning the received signal has to drop by 35% to trigger the fire relay. This sensitivity can be adjusted between 25% (**sensitive**) and 50% (**less sensitive**))

Time to Fire

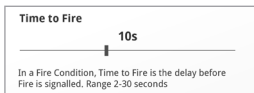

Adjust how long the beam has to be in fire before the fire relay is triggered. This is factory set at 10s, you may want to increase this if there is something that may momentarily obscure the beam path (birds / forklift truck). Using the slider this can be adjusted between 2 and 30 seconds

Time to Fault



Adjust the time to fault between 2 and 30 seconds (**factory set at 10 seconds**). For a beam to go into fault the beam path must be totally blocked within **ONE** second

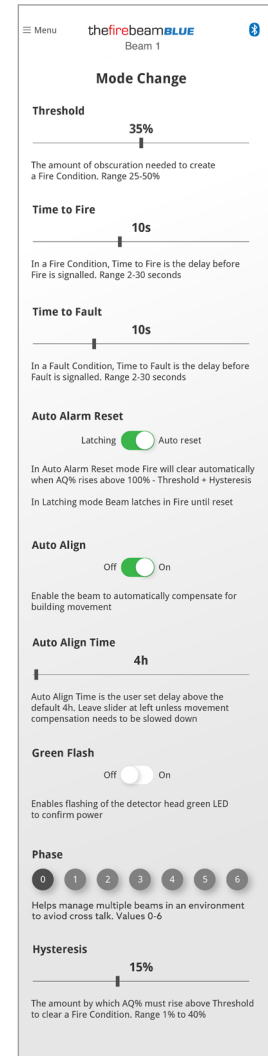

MODE CHANGE continued

Auto Alarm Reset

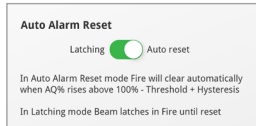

The beam is factory set to auto reset when the received signal raises above the fire threshold hysteresis. This can be set to latching if your system requires this

Auto Align

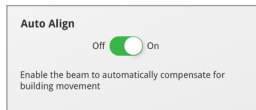

You may want to turn the auto alignment function off, for example, in an environment that often gets filled with welding smoke or has unwanted reflections the auto align function kicks in when the received signal drops below 90%, the point that the beam automatically checks for building movement. The beam will try to align through the smoke which could be a problem if it is unable to see the edges of the reflector. Use the slider to turn off and on. When turning this function off extra care should be taken to ensure that the beam head is on a sturdy fixing i.e. a brick wall or major structural steel. Auto alignment will still function in commissioning

Auto Align Time

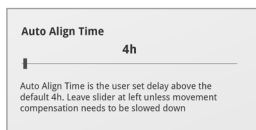

This is factory set to 4hrs, you can adjust this, by using the right and left keys, between 0 to 12 hours depending on your environment

Green Flash

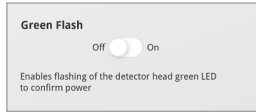

You can turn the green flashing LED located on the head **on** or **off**

Phase

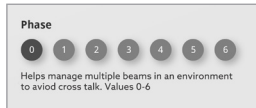

When using multiple beams that **face each other** the beam output signals could phase together and can cause unreliable cross talk readings, by setting **each facing beam to a different Phase number** alleviates this problem. You can choose between **0** (default setting) and **6**

Hysteresis

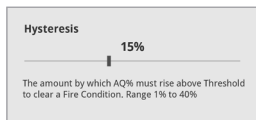

Changing the hysteresis will change the delay in returning from a fire state back to a normal state, for example, the beam is factory set at 15% so if the beam falls into fire at 65% (35% threshold) it has to recover 15% to 80% before it returns to normal. This action prevents small fluctuations in returned signal causing the beam to fall in and out of a fire state. This can be adjusted between **1%** and **40%**

MAINTENANCE

Here we can see if any compensation has been made for dust build up and whether any alarm or faults have occurred. You can also turn the beam off here

Dirt Compensation

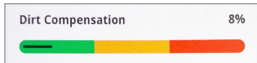

This screen shows how much the beam has compensated for dust build-up on the beam head and reflectors, **ALWAYS** take a note of

this value as part of your routine maintenance to see any build-up pattern. A green, amber, red 'traffic light' indicator will inform you when the lens and reflector need cleaning

(once cleaned you should instigate an auto alignment to re-calibrate the beam settings).

It is possible that you may see a negative number here, this can happen when the beam has been commissioned in a 'dirty' atmosphere such as builders dust which, once cleared, the beam then compensates for this

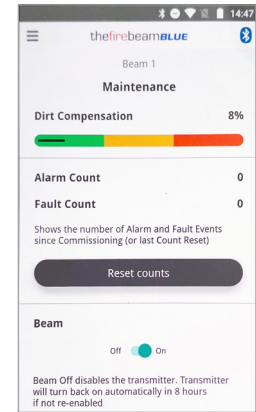

Alarm and Fault Count

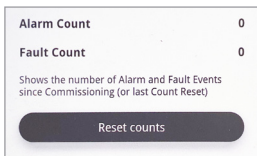

Here we can see how many times the beam has gone into fire or fault since the beam was commissioned or since the event log was last cleared including testing. You can also reset the counts here

Beam On - Off

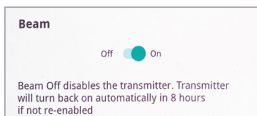

If you may need to turn the beam off, it can be turned **off** and **on** here. Turning off will show as a fault on the panel

DIAGNOSTICS

Here we can see, monitor and adjust the output power and the receiver sensitivity. We can also see the temperature at the beam head

Output Power

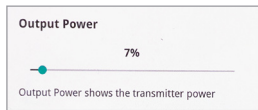

This shows the amount of Output Power that is being transmitted. It can be increased or decreased by using the slider

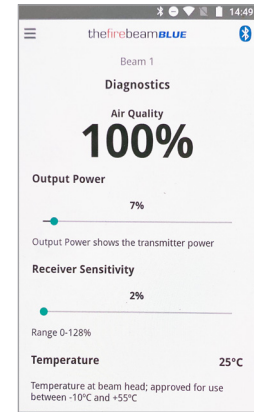

Receiver Sensitivity

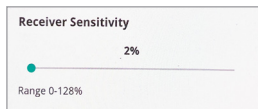

Here shows the Receiver Sensitivity and can be changed by using the slider. The range is between 0 & 128%

Notes: by changing the Output Power or Receiver Sensitivity you are changing a commissioned beam's settings. It is advisable to re-test your beam to check suitability of any changes made

Temperature



The Temperature shown is at the beam head. The beam is approved between -10°C and +55°C

FAQ's. When using the menu system a comprehensive list of FAQ's can be found on www.firebeamsupport.com

FIRE TEST

A Fire Test can be performed here to test correct signalling at the beam and Panel

You must also confirm the beam is [aligned on the Reflector](#) as per the Testing guide on page 17

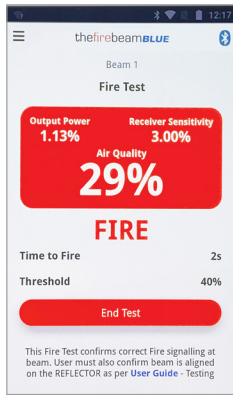

Fire Test

Press [Start Test](#) to perform a fire test, this works by running a test algorithm to lower the output power, the receiver sees this as obscuration. When the received signal drops [below](#) the threshold point the beam will trip the fire relay – [this relay will not trip until the time to fire has passed](#) which could be anything between 2 and 30 seconds

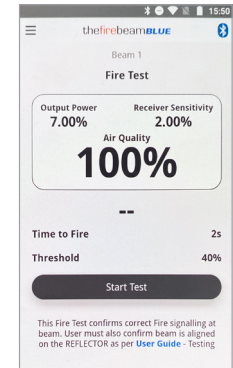

CONNECT TO FIREBEAM

You use this screen to scan and connect to your beam of choice

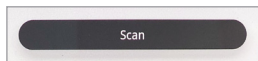

Pressing Scan will reveal all the [Firebeams](#) within range.

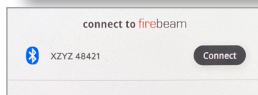

Press [Connect](#) to communicate with your chosen beam. This will take you back to the Home Screen for that beam

Disconnect

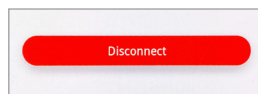

When you have finished working on your beam simply return to the connect menu and press [Disconnect](#) this will return you to the connect to beam screen. From here you can select another beam to work with

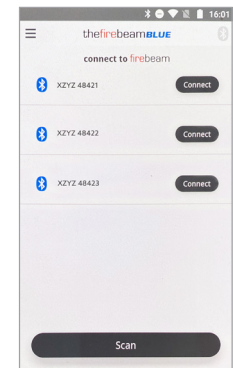

Notes: to allow another mobile device to find the powered beam, [the App should be disconnected once the beam has been commissioned](#). The App is not used during operation of the beam, only commissioning

⚙️ SETTINGS

You use this menu to change your language choice, change a beam's name, set an optional passcode if desired with the ability to change or remove it, delete your App user account and to logout



Languages

The default language is English. You can change the language to your own choice here

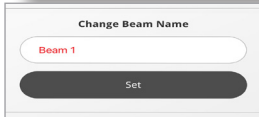

Change Beam Name

Change the beam name by keying in a new name here. Press Set to confirm your choice

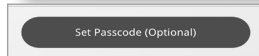

Set Passcode (Optional)

Set an optional 6-digit numerical passcode for your detector head

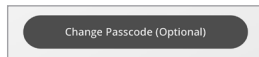

Change Passcode (Optional)

Change the passcode for your detector head



Remove Passcode

Remove the passcode from your detector head



Delete Account

If you no longer use the firebeamBLUE App and want to remove your registration, **Delete Account** and enter your registration password to remove your account details. You will no longer be able to use the firebeamBLUE App

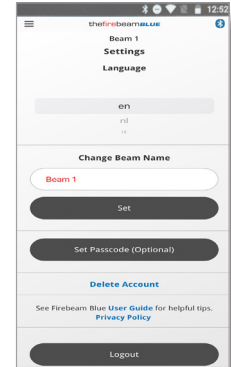

Passcode Reset

If you have forgotten your passcode, you can remove the passcode with the following process:

1. Power off the beam and wait at least 15 seconds for the relay "click" to confirm power has dissipated from the head
2. Power back on the beam
3. After 20 seconds power off the beam again and wait at least 15 seconds for the relay "click" to confirm power has dissipated from the head
4. Power back on the beam. Passcode will no longer be present

FAQ's. When using the menu system a comprehensive list of FAQ's can be found on www.firebeamsupport.com

TECHNICAL SPECIFICATION

Electrical Specifications

Supply Voltage 12 to 30 Vdc normal

Supply Current 5.5mA in all operational states

Supply Current 13.5mA in fast commissioning

Environmental Specifications

Temperature -10°C to +55°C

Humidity 10 to 95% RH Non-condensing

Protection Index IP65 when suitably mounted and terminated

Mechanical Specifications

Beam Head

180mmH x 155mmW x 137mmD
Weight 1.1Kg

70KIT140 Mid-Range Reflector

293mmH x 293mmW x 5mmD
Weight 0.8Kg

140KIT160 Long Range Reflector

394mmH x 394mmW x 5mmD
Weight 1.8Kg

Adapter

270mmH x 250mmW x 5mmD
Weight 0.6g

(mounts the Beam Head onto unistrut)

Optical Specifications

Optical Wavelength 870nm

Maximum Angular Alignment $\pm 5^\circ$

Maximum Angular Misalignment

(static not auto-aligning)

Beam Head $\pm 0.4^\circ$ Reflector $\pm 2^\circ$

Operational Specifications

Protection Range

FIREBEAM

Standard Product 7 to 70 metres. Use short range mask for distances between 7 & 20 metres

70KIT140

Mid-Range Reflector Kit 70 to 140 metres

140KIT160

Long Range Reflector Kit 140 to 160 metres

Alarm Sensitivity Levels

25%(1.25dB) to 50%(3dB) in 1%(0.05dB) increments
(default 35% (1.87dB))

Alarm Condition

Obscuration drops to below pre-defined sensitivity level.
Time to Alarm Condition adjustable
2 to 30 seconds in 1 second increments
(default 10 seconds)

Alarm Indication

App Status - FIRE
Head Red Flashing LED
Alarm Relay Change Over (CO) Contact
Rating 2A @ 30 Vdc

Test/Reset Features

Beam test function with App

Alarm latching/auto-reset selectable
(default auto-reset)

Alarm reset in latching mode with App reset function, removing power for >5 seconds or momentarily apply >5 VDC to reset connections in Beam Head

Fault Sensitivity Level

<4%

Fault Condition

Obscuration drops to below the fault sensitivity level within 1 second
Power Down or Supply Voltage < 9 VDC
Commissioning modes, Pre-Alignment and Auto Alignment

Beam turned off during Beam Maintenance Time to Fault Condition adjustable,
2 to 60 seconds in 1 second increments
(default 10 seconds)

Fault Indication

App Status - FAULT

Head Yellow Flashing LED 1 Second

Fault Relay Change Over (CO) Contact
Rating 2A @ 30 VDC

Normal Condition

Obscuration level is above the Alarm sensitivity level

App Status - NORMAL

Programmable on/off

Head Green Flashing LED

Programmable on/off

Auto-align/Beam Contamination Compensation

Auto-align during normal operation if obscuration drops below 90% for the duration of the align time set
(doesn't effect normal operating mode)

Beam Contamination Compensation 4 hour monitoring. Compensation data available in the App

In accordance with the Radio Equipment Directive 2014/53/EU

The frequency band in which the radio equipment operates is 2400-2483.5 MHz.

The maximum equivalent isotropic radiated power (EIRP) in which the radio equipment operates is 6.51 dBm.

Disposal of Waste Electrical and Electronic Equipment (WEEE) in accordance with WEEE Directive 2012/19/EU



Must be disposed of correctly at the end of its working life and should never be disposed of together with general household waste. Users can take the equipment for disposal to an appropriate civic amenity site authorised for the collection of electrical and electronic waste.

The Firebeam Company Limited is a member of a producer recycling scheme, customers can also return Firebeam products to us free of charge for treatment and recovery in an environmentally sound manner.

Regulatory Information



Declaration of Performance
see DoP-002-05-22

The Firebeam Company Ltd. Unit 8, Thames Industrial Estate, LU6 3HL, UK

EU: 0786-CPR-21735 UK: 0843-CPR-1131

EN 54-12

Line-type smoke detector: Firebeam Blue
Intended for use in fire detection and fire alarm systems in buildings

Operational reliability:

Individual alarm indication: *Red LED*
Connection of ancillary devices: *Correct operation*
Manufacturer's adjustments: *Special means required*
On-site adjustment of response value: *Special means required*
Protection against ingress of foreign bodies: *Protected (> 1.3mm)*
Monitoring of detachable detectors and connections: *Fault signal released*
Requirements for software-controlled detectors: *Documentation, design and storage correct*

Nominal activation conditions / sensitivity:

Reproducibility: $C_{min} > 0.4dB$, $C_{max}/C_{rep} < 1.33$; $C_{rep}/C_{min} < 1.5$
Repeatability: *Correct operation*, $C_{min} > 0.4dB$; $C_{max}/C_{min} < 1.6$
Tolerance to beam misalignment: *Maximum angle* $> 0.4^\circ$
Rapid changes in attenuation: *Correct operation*
Response to slowly developing fires: *Correct operation*
Optical path length dependence: $C_{min} > 0.4dB$; $C_{max}/C_{min} < 1.6$
Stray light: *Correct operation*: $C_{min} > 0.4dB$; $C_{max}/C_{min} < 1.6$

Tolerance to supply voltage:

Variation in supply parameters: $C_{min} > 0.4dB$; $C_{max}/C_{min} < 1.6$

Performance under fire conditions:

Fire sensitivity: $ma < 0.7 dB m^{-1}$

Durability of nominal activation conditions / sensitivity:

Temperature resistance

Dry heat (operational): *Correct operation*, $C_{min} > 0.4dB$; $C_{max}/C_{min} < 1.6$
Cold (operational): *Correct operation*, $C_{min} > 0.4dB$; $C_{max}/C_{min} < 1.6$

Humidity resistance

Damp heat, steady state (operational): *Correct operation*, $C_{min} > 0.4dB$; $C_{max}/C_{min} < 1.6$
Damp heat, steady state (endurance): $C_{min} > 0.4dB$; $C_{max}/C_{min} < 1.6$

Vibration resistance

Vibration, (endurance): $C_{min} > 0.4dB$; $C_{max}/C_{min} < 1.6$
Impact (operational): *Correct operation*, $C_{min} > 0.4dB$; $C_{max}/C_{min} < 1.6$

Electrical stability

EMC Immunity tests (operational): *Correct operation*, $C_{min} > 0.4dB$; $C_{max}/C_{min} < 1.6$

Corrosion resistance

Sulphur dioxide (SO2) corrosion (endurance): $C_{min} > 0.4dB$; $C_{max}/C_{min} < 1.6$

Simplified EU declaration of conformity in accordance with the Radio Equipment Directive 2014/53/EU

Hereby, The Firebeam Company Limited, declares that the radio equipment type Firebeam Blue is in compliance with Directive 2014/53/EU. The full text of the EU declaration of conformity is available at the following internet address:
https://www.thefirebeamcompany.com/user-zone/pdf/Fire_Beam_Declaration_of_Conformity.pdf